

Article number: 021816011386

Description: Clamp with bracket and rubber
SPGU 6011. 386/30 SK

Measures

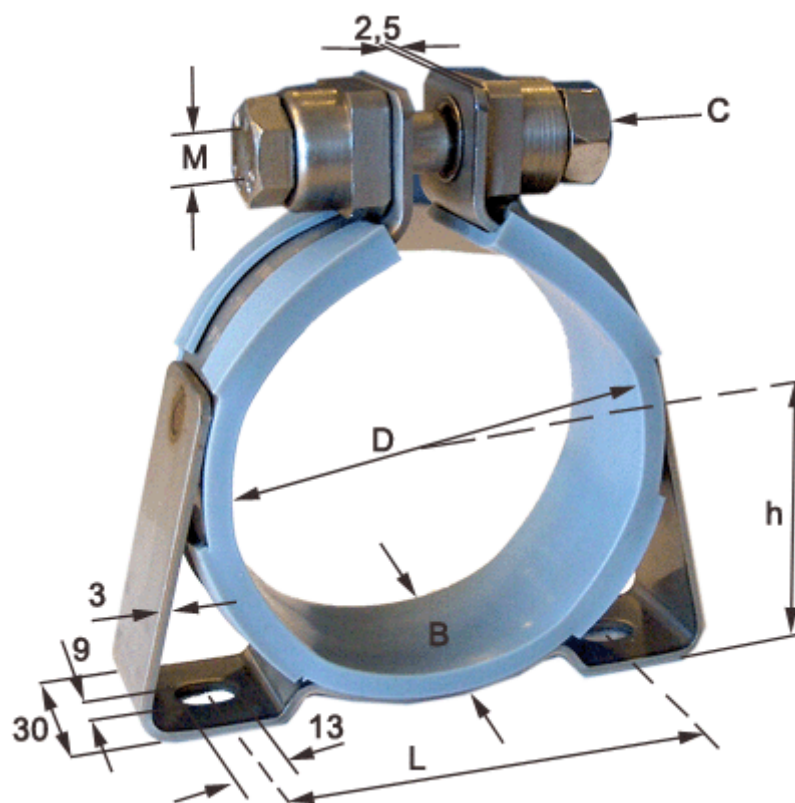

C (screw type) = SK hexagon screw

Diameter D = 386

h = 201

L = 360

Width B = 30